



Translation of the original operating manual

GP 600 M1

**Read carefully before initial
operation!**

Version: 06/2017, V1.5



	Technische Produkte 3753 Holzelsdorf Austria	
Modell:	<input type="text"/>	
Type:	<input type="text"/>	
Fab. Nr.:	<input type="text"/>	
Kontrolle:	<input type="text"/>	Baujahr:
Basisgew.:	<input type="text"/> kg	<input type="text"/>

Order no.: 00600-3-287

It may NOT

seem inconvenient and unnecessary to read and observe the operating instructions. It is not enough to hear and see from others that an implement is good, and then to buy it and believe that everything takes care of itself. The person concerned would then not only cause damage to himself, but also make the mistake of assuming that the cause of any problems is due to the implement, instead of himself. To ensure success, one has to go into the spirit of things, and instruct oneself about the purpose of all equipment on the implement and gain experience with its handling. Only then can one be satisfied both with the implement and oneself. These operating instructions aim to achieve this.

Leipzig-Plagwitz 1872

Table of contents

1	EC Declaration of Conformity	4
2	Provisions.....	5
3	Warranty.....	5
4	Accident prevention	5
5	Transport on public roads (most important specifications)	6
5.1	Loading and unloading.....	6
6	Operating manual for APV GP 600 M1	7
6.1	Mounting on the tractor	7
6.2	Coupling	8
6.3	Uncoupling.....	9
7	Layout and mode of operation	10
8	Working position and setting the working depth.....	11
8.1	Depth adjustment / drawbar adjustment.....	11
8.2	Adjusting the series of holes	11
8.3	Levelling board	12
8.4	Turning at the headland	12
8.5	Use of individual tools	13
8.6	Folding lock.....	13
9	Cropping tips for using the GP 600 M1	14
10	Maintenance and care	15
10.1	General.....	15
10.2	Changing the tines.....	16
10.3	Tine safety	16
11	Location of the rating plate.....	16
12	Lubrication schedule.....	17
13	Technical Specifications	18
14	Road transport of the GP 600 M1	20
15	Lighting circuit diagram.....	20
16	Accessories	21
16.1	Compressed air system (only when ordered separately).....	21
16.1.1	General	21
16.1.2	Draining.....	21
16.1.3	Readjusting the brake system	22
16.1.4	Measuring the compressed air	22
16.1.5	Pneumatic brake system diagram	23
16.2	Operating hours counter	24
16.3	Lighting with warning signs (on both sides).....	24
16.4	Mounting kit for PS120 - 500.....	24
16.5	Filling steps.....	25
16.6	Toolbox accessories kit.....	26
16.7	Sensor set – Radar + lifting unit sensor for the GP 600 M1	26
17	My idea.....	31
18	Safety instructions	32
18.1	Intended use.....	32
18.2	General safety-related instructions and accident prevention regulations.....	33
18.3	Mounted implements.....	35
18.4	Hydraulic system.....	35
18.5	Maintenance	36
19	Safety signs.....	37

1 EC Declaration of Conformity according to the EC Machinery Directive 2006/42/EC

We hereby declare that the implement (exchangeable equipment) described in the following meets the basic safety requirements in Annexe I of the EC Machinery Directive 2006/42/EC.

This declaration loses its validity in cases of non-intended use and if changes are made to the implement that were not approved by the manufacturer.

Manufacturer:	APV-Technische Produkte GmbH, Dallein 15, A-3753 Hötzelstdorf
Designation of the product:	Grassland power harrow GP 600 M1
Number:	MA-5
Serial number:	all serial numbers for the Grassland power harrow GP 600 M1
Legal authorised person for the technical documents:	APV-Technische Produkte GmbH, Dallein 15, A-3753 Hötzelstdorf
Conformity procedure:	Machinery Directive 2006/42/EC Annex I

Conformity with the following directives:

2006/42/EC Machinery Directive
2004/108/EC EMC Directive

Applicable standards:

EN 349 Safety of machinery – Minimum gaps to avoid crushing of parts of the human body
EN 60204-1 Safety of machinery – Electrical equipment
ISO 12100 Safety of machinery; General principles for design; Risk assessment and risk reduction
ISO 13857 Safety of machinery – Safety distances
ISO 14982 Agricultural and forestry machinery — Electromagnetic compatibility — Test methods and acceptance criteria

Dallein, June 2017
City, Date



Signature

Ing. Jürgen Schöls
Managing Director

2 Provisions

Dear customer!

We are pleased and congratulate you on your purchase and wish you lots of fun and success in working with this implement!

Please be sure to read all the instructions in this operating manual before operating the implement!

3 Warranty

Please check the implement for any transport damage immediately upon receipt. Later claims regarding transport damage can no longer be considered.

We provide a six-month factory warranty as of the date of delivery (your invoice or the delivery slip serve as a warranty certificate).

This warranty is applicable for cases of material or construction faults and does not include parts that are damaged by normal or excessive wear.

The warranty expires

- if damage is caused by external forces.
- in cases of operating errors.
- if the kW/HP limits are significantly exceeded.
- if the implement is modified, expanded or equipped with third-party spare parts without our permission.

4 Accident prevention

The general accident prevention regulations of the respective countries must be observed.

Always secure the parked implement against unintentional rolling.

The implement may only be used by persons who are informed of the hazards and who know the regulations for transport on public roads.

5 Transport on public roads (most important specifications)

The axle load and the total weight of the towing vehicle may not be exceeded. The mounted implement must be identified with warning signs or stickers with red and white slanted lines (according to DIN, ÖNORM or respective STANDARDS) (Fig.: 1).

Any part posing a traffic hazard or dangerous parts must be covered and additionally identified

with warning signs or stickers. Warning signs or stickers should be visible at a height of max. 150 cm above the road when driving.

Lighting equipment of the towing vehicle may not be hidden by the implement, otherwise they must be replicated on the mounted implement.

The steering capacity of the tractor must not be impeded or reduced by the mounted implement!



Fig.: 1

1. 2 rear lights, turn signal and brake lights (optional)
2. 2 square warning signs (optional)
3. Limiting lights (optional)

5.1 Loading and unloading

- The implement is folded, the running gear is lowered (Fig.: 2).
- Put the implement down lengthwise on the low-bed trailer (Fig.: 2).
- The low-bed trailer must have the required ground clearance.
- Lashing points:
 - Drawbar (Fig.: 3)
 - Roller frame (middle) (Fig.: 4)
 - Roller frame (side) (Fig.: 4)

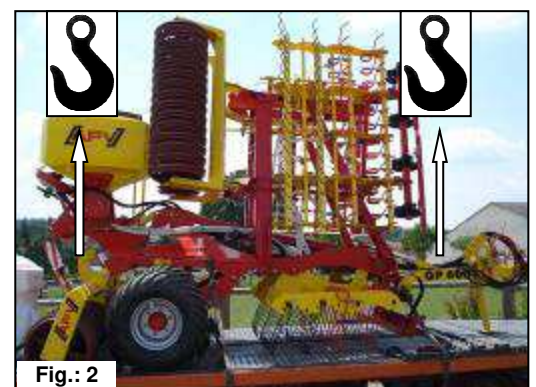
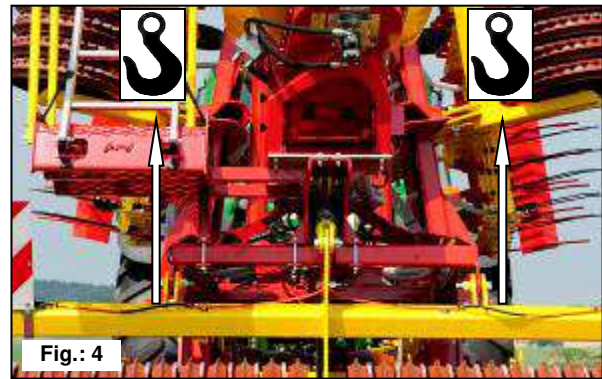
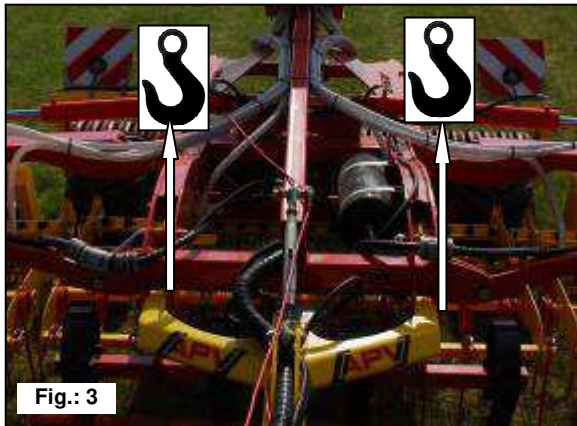

Fig.: 2



6 Operating manual for APV GP 600 M1

6.1 Mounting on the tractor

- The air pressure in the rear tractor tyres should be 0.8 bar during operation. If the tyres have a lower load capacity, increase the pressure.
- Under difficult operating conditions, additional wheel weights can be useful. Please also refer to the operating manual from the tractor manufacturer.
- The tractor should be equipped with sufficient ballast weight at the front to ensure the steering and braking capacity. At least 20 % of the empty vehicle weight is required on the front axle.
- The lifting struts must be adjusted to the same height and locked on the left and on the right.
- The implement must be mounted on the standard lower link or towing hitch.
- Also refer to the sticker on the implement (observe the specifications of the tractor manufacturer).
- After coupling the lower link, fold up the parking support by pulling out the pin and then reinserting the pin and locking it (Fig.: 5 and 6).



- Connect the hydraulic hoses to 3 double-acting control units. During connection, make sure that the hoses are unpressurised both on the tractor and implement sides.
- Secure the implement against rolling away.
- Special care must be taken when driving the tractor in reverse. It is forbidden to stand between the tractor and the implement.
- The implement should only be parked on level and solid ground. Before uncoupling, the implement should be lowered onto the ground.

6.2 Coupling

- Lock the tractor lower link against lateral movement so that it does not start swinging while driving.
- Connect the GP 600 M1 to the tractor lower links, they are standardised according to CAT 3N. This means that the balls have a lateral distance of 965 mm. The width of the ball is 45 mm.
- Connect the brake system (optional).
- Remove the wheel chocks (optional) and hang them in the intended holder.
- Release the parking brake (optional).

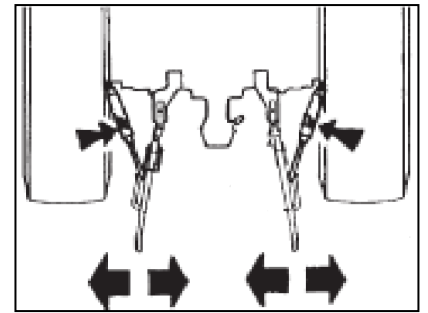

Fig.: 7



CAUTION: Pay attention to the sequence for the connection! First couple the yellow brake line, then the red.

- Connect the hydraulic hoses, lighting (optional) and electric cables (check the function of the lights).

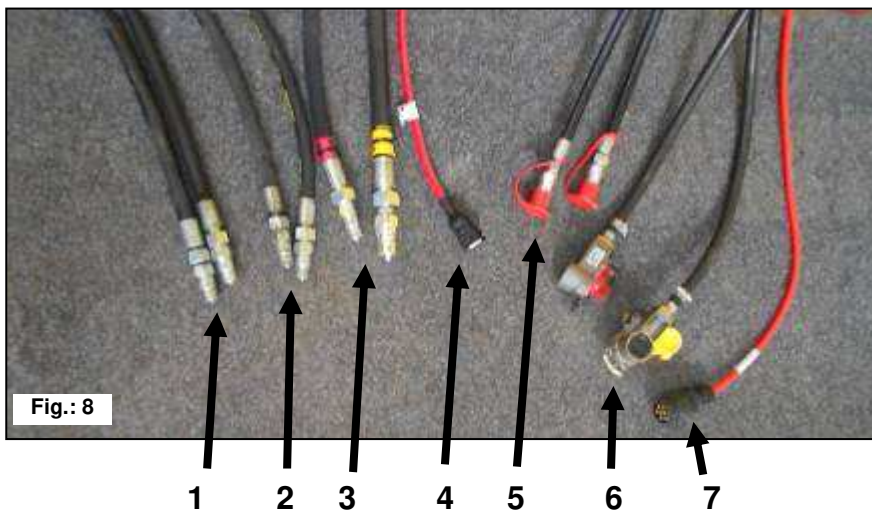

Fig.: 8

1. Hydraulic connections for the roller (yellow)
2. Hydraulic connections for the running gear (black)
3. Hydraulic connections for the PS implement plus pressureless return (optional)
4. Implement cable for the PS implement (optional)
5. Hydraulic connections for the folding mechanism (red)
6. Connections for the pneumatic brakes (optional)
7. Lighting for the GP 600 M1 (optional)



CAUTION: Only connect the hydraulic hoses when the hydraulic system on the towing vehicle and the GP 600 M1 are unpressurised.

- Lift and secure the parking support of the implement.
- Check that the hoses and cables are hanging freely, so that they are not damaged when driving in tight curves.

6.3 Uncoupling



Fig.: 9

- Uncoupling and lowering the implement onto the ground must always take place on a level and solid surface.
- Lower and secure the parking supports of the implement.
- Adjust the main cylinder and the parking support so that the implement is resting on the wheels, the roller, and the support. Make sure that the support is standing on solid ground.
- Close the stop tap. Switch off the control box.
- Remove the GP from the towing device of the tractor.
- Disconnect the hydraulic hoses and electric cables and then hang them up in the corresponding holder (Fig.: 10).
- Disconnect the pneumatic hoses (optional) and put them on the holder. (First disconnect the red hose, then the yellow one!)



Fig.: 10

7 Layout and mode of operation

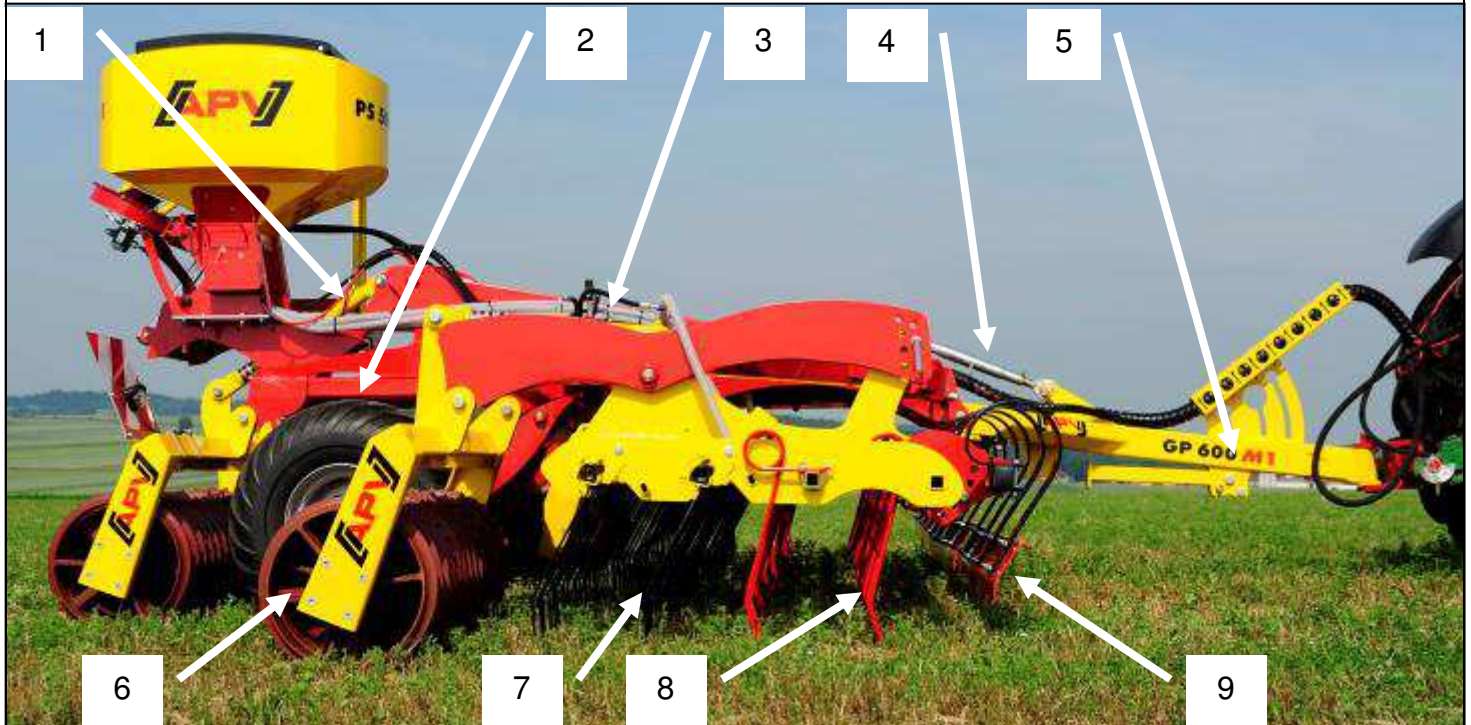

Fig.: 11

1. Roller cylinder
2. Running gear
3. Folding cylinder
4. Spindle / drawbar cylinder (optional)
5. Drawbar
6. Cambridge roller
7. 8 mm tines
8. 12 mm tines
9. Levelling board

Thanks to its robust and compact design, the grassland power harrow GP 600 M1 is ideal for new seeding, reseeding, and controlling grass weeds on grassland.

The spring-suspended front levelling board ensures optimal distribution and levelling of mole hills, manure, slurry and cow pats.

Due to the narrow line distances of the individual tines (75 mm for 12 mm tines and 50 mm for 8 mm tines), the sod is optimally prepared and the plants can germinate rapidly after re-seeding.

With the high contact pressure of the utilised roller, soil closure over the seed is improved and the nutrient supply to the reseeded plants is optimised.

To obtain the best possible rolling results, a forward speed of 8 km/h should not be exceeded. A speed of 6-12 km/h is ideal for grassland.

8 Working position and setting the working depth

8.1 Depth adjustment / drawbar adjustment

To adjust the depth of the GP 600 M1, 2 work steps are required.

1. Depending on how aggressively you want to work the soil, add or remove the hydro clips from the roller cylinder. To do so, you must extend the cylinder a little so that the hydro clips are hanging freely on the cylinders. When you have inserted the desired number and sizes, retract the cylinders again up to the stop.

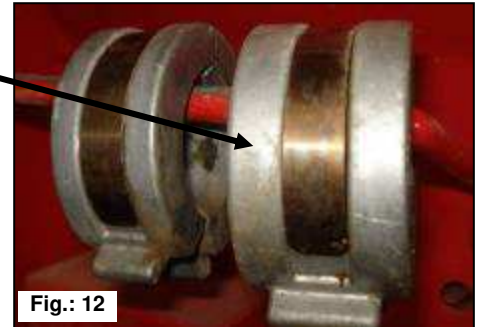

Fig.: 12



PLEASE NOTE: The same number with the corresponding sizes must be installed on all cylinders.

2. The lower link must be positioned such that the frame of the implement is parallel to the field. With the position of the lower link, the working depth can also be adjusted as required.
3. To adjust the implement perfectly, the drawbar must also be adjusted. This is achieved with the spindle or the drawbar cylinder (optional).



TIP: Check the working depth after driving 10 m and readjust if necessary. For larger areas, it is recommended to check the working depth of the tines intermittently.

If you want to use the GP 600 M1 with the roller lifted, i.e. the roller in the highest position and the roller cylinder completely retracted, you must support the implement on the running gear. It is then no longer possible to completely lift the running gear off of the ground.

The higher you lift the roller, the more weight is resting on the tines.

8.2 Adjusting the series of holes

In addition to the depth, the aggressiveness of the tines relative to one another on the GP 600 M1 can also be changed. To do so, you only have to insert the pins for the harrow arrays as desired in a higher or lower hole (see Fig.: 13).

This makes it possible to adjust the 12 mm and the 8 mm tines at different degrees of aggressiveness. This also allows for compensation of various degrees of wear on the tines.



Fig.: 13

The two front tine rows tear up the sod. The rear tine rows produce an optimal seedbed for the new grasses. If the front row of tines should work more aggressively (e.g. under hard soil conditions), you must place the pin in one of the bottom holes. On soft soils or wet conditions, you can have only the rear tines working by adjusting the series of holes higher up.

After this adjustment, you also have the option of changing the work pattern of the rear tines.

For this purpose, you can select one of four levels. At an optimal forward speed, the tines make an elliptical motion. The steeper the position of the tines, the smaller the motion. The flatter the position of the tines, the larger the motion. If the sod is dense and intense tillage is required, the tines should be positioned more steeply (Fig.: 14).



Fig.: 14

Aggressiveness adjustment

8.3 Levelling board

The levelling board eliminates mole hills after the winter and serve to roughly level the grassland. The height should be adjusted so that it runs along the sod just above the ground. It should not scratch into the sod. However, if the sod is very uneven, allowing the levelling board to slightly penetrate into the soil can improve the levelling effect on the long term.

8.4 Turning at the headland

1. Turning with the roller:
When turning at the headlands, first the lower links are raised, then the roller is pressed down so that the GP 600 M1 is running on the roller. It is necessary to raise the lower links when driving with a very aggressive tine position.

When driving with control hydraulics, the lowest control height must be limited just below the normal working depth, otherwise the control hydraulics would be lowered at the front when lifting.

If the tractor does not have headland management, we recommend turning with the roller.

2. Turning with the running gear:
You can also raise the GP 600 M1 using the running gear and then turn.
Here, we also recommend raising the lower links.

8.5 Use of individual tools

With the GP 600 M1, it is possible to use the individual tools

- Levelling board
- Harrow
- Roller
- Seeding unit (optional)

Can be used separately or in any combination. For example, you can use the roller alone by completely extending the roller cylinder. In this way, you can also use the implement on field crops for rolling after seeding (see Fig.: 13, 8.2 Adjusting the series of holes).

If you only want to level and roll, position the roller and the levelling board all the way down so that the harrow array is lifted off the ground.

If you only want to pass with the harrow, you must raise the roller completely, move the levelling board up, and put the implement down on the running gear.

8.6 Folding lock

To secure the side harrow arrays against accidental unfolding, the stop valve must be closed.

Without opening the stop valve mechanically, it is not possible to accidentally unfold.



CAUTION: For road transport, the folding mechanism always has to be locked, this means that the stop valve must always be closed for road transport.



CAUTION: Remove the chain before unfolding, otherwise damage can be inflicted to the frame.

9 Cropping tips for using the GP 600 M1

Seedbed preparation is always required before reseeding. This procedure is optimally accomplished with the grassland power harrow GP 600 M1 with 4 rows of tines. Together with the reconsolidation by a roller, five working procedures are accomplished in one field pass.

With its thorough and effective mode of action, the GP 600 M1 can be optimally integrated in your overall management concept.

The goal of your concept will be to improve yields and to increase the valuable grasses.

Other effects of the GP 600 M1, such as

- soil aeration,
- regulation of the water balance,
- incorporation of the seed,
- reconsolidation,
- pressing down the seed and therefore
- promoting tillering

make a significant contribution to the formation of good crops.

The success of weed control without chemicals and high yields, however, depend very strongly on you, as you will be required to closely observe the processes in your soil.

Reseeding of grassland is theoretically possible during the entire frost- and snow-free period. Gaps in the crops should already be reseeded in the spring to prevent weed competition. As a matter of principle, you should reseed more frequently and therefore work less aggressively and reduce the seed quantity.

Reseeding can be performed in the spring as soon as the soil has warmed up a little. The soil must have good trafficability, i.e. the seed should not be "smeared in" in any case.

Reseeding in the spring has the advantage that the spring humidity and the disturbed soil can be used as a seedbed. However, despite the good start, the grass can dry out during a summer drought, and the pressure of the old sod is greater in the spring due to the stronger growth spurt.

With the GP 600 M1, we counteract this disadvantage with a roller that presses down the seed and therefore improves soil closure. This allows the seed to germinate more rapidly and the risk of desiccation is reduced.

The optimal strength and depth setting, forward speed and the adjustment of the tines and seeding rate must be set with your understanding of the correlations between the soil properties and weather conditions, which can vary greatly in different regions.

10 Maintenance and care

10.1 General

To maintain the implement in good condition even after a long service life, the following instructions must be observed:

- ✓ In the supplement "For your safety..." you will find some basic safety regulations for maintenance work.
- ✓ Original parts and accessories are designed especially for the machines or implements.
- ✓ Please note that spare parts and accessories not supplied by us have also not been tested and approved by us.
- ✓ The installation or use of such products can therefore possibly negatively change or impede the constructional properties of your implement. The manufacturer rules out any liability for damages resulting from the use of non-original parts and accessories.
- ✓ The manufacturer is not liable for any unauthorised modifications and the use of components and auxiliary parts.
- ✓ All bolted connections should be re-tightened at the latest after 3 operating hours and again after 20 hours, and then checked regularly. (Loose bolts can cause significant consequential damage, which is not covered by the warranty.)
- ✓ The grease points on the joints and bearings must be lubricated regularly (approx. every 10 operating hours with universal grease).
- ✓ For implements with quick coupling, the guide slots must also be lubricated.
- ✓ After the first 10 operating hours and subsequently every 50 operating hours, the hydraulic units, hydraulic hoses and hydraulic couplings must be checked for leaks and the bolted connections must be tightened if necessary.
- ✓ The wheel nuts must be checked and retightened every 50 km.
- ✓ Check the hydraulic hoses for wear before every operation.
- ✓ Caution! Liquids escaping under high pressure can penetrate the skin. For this reason, a physician must be consulted immediately in case of accident!
- ✓ After cleaning, lubricate all of the grease points and distribute the grease evenly in the bearing points (e.g. perform a short test run).
- ✓ Do not use a high pressure cleaner to clean bearing and hydraulic parts.
- ✓ The paint can be damaged by cleaning with excessive pressure.
- ✓ During the winter, the implement should be protected against rust with an environmentally-friendly product.
- ✓ Park the implement protected from weather conditions.
- ✓ Put down the implement in a way that the tines are not needlessly strained. (Roller all the way down, use the parking supports at the front.)

10.2 Changing the tines

To replace broken or worn tines, all you have to do is loosen the nut and take out the tine.

- ✓ As shown in Fig.: 15, you must hook on the new 12 mm tines and re-tighten the nuts. Pay attention to the proper line distance! The tines in the rear row cut the distance of the front tines in half.
- ✓ As shown in Fig.: 16, the 8 mm tines must be fastened with the bolt. Ensure that the bolt rests firmly on the tine and that all tines form a straight line. There should be a washer above and below the tine as well as a washer under the bracket.

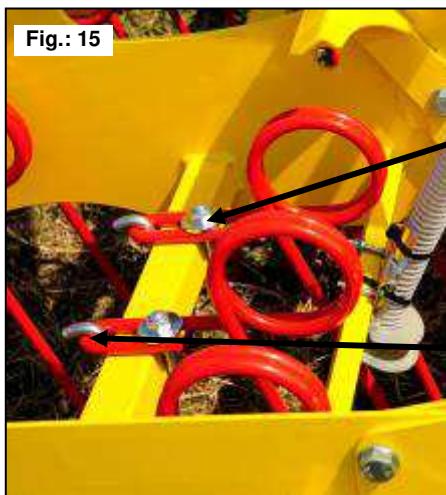

Fig.: 15

Unscrew the nut

Hook for fixing

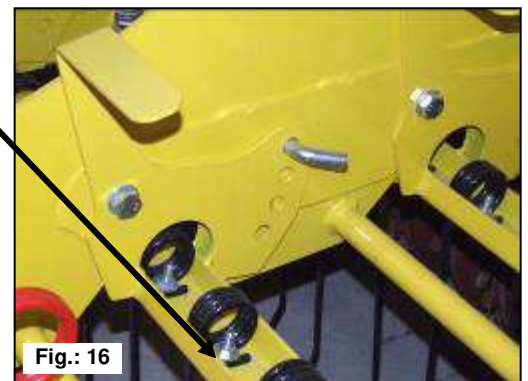

Fig.: 16

10.3 Tine safety

As standard, the GP series is equipped with a tine safety that prevents loss of the 12 mm tines by means of a rope. It protects the tines so that they do not get lost on the pasture or on the field. This also prevents damage to other implements, e.g. the mower or the baler.

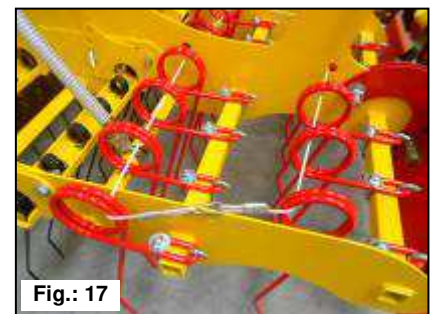

Fig.: 17

11 Location of the rating plate

The rating plate is located on the left of the middle frame.

In cases of inquiries or warranty claims, please always tell us the production number of your machine.

Technische Produkte
3753 Hötzelsohn
Austria

APV

Modell:

Type:

Fab. Nr.:

Kontrolle:

Basisgew.: kg

Baujahr:

CE

Fig.: 18

12 Lubrication schedule

The following grease points on the joints and bearings must be lubricated regularly with universal grease (approx. every 10 operating hours).

1. 1x bearing on the tractor linkage drawbar, lateral slope compensation (Fig.: 19)
2. 1x pin, pivot point when driving in curves (Fig.: 19)
3. 2x at the end of the drawbar (left and right) (Fig.: 20)

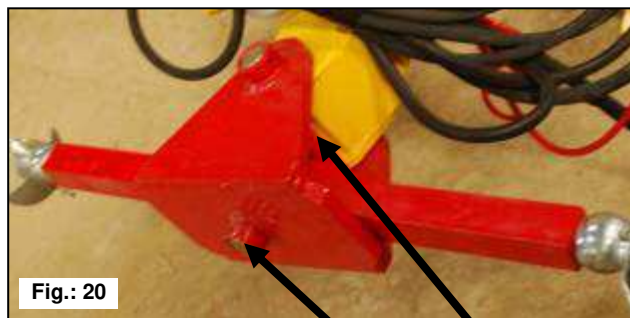

4. 4x the pins on the pivot points when folding and unfolding (left and right) (Fig.: 21)
5. 2x bearing between the running gear and the frame (Fig.: 21)
6. 8x roller, the bearing at the ends of the roller (Fig.: 21)
7. 4x folding cylinder
8. 2x running gear cylinder

13 Technical Specifications

Type designation:	GP 600 M1
Mode of action:	Levelling with leaf springs with wear plate 2 rows of aggressive round spring tines 2 rows of harrow round tines Pressure-adjustable reconsolidation
Working width:	6.00 m
Transport width:	3 m
Dimensions (W x H x L):	3 x 3.1 x from 5.2-5.7 m (folded)
Working depth:	0-40 mm
Number of tines	112/78 pieces [Ø8/Ø12 mm]
Line distance	50 mm/75 mm [Ø8/Ø12 mm]
Net weight	4800 kg with Cambridge roller d = 530 mm 4800 kg with tooth roller d = 410 mm
Leading tools	Levelling is spring-suspended and height-adjustable
Working tools	Round spring tines
Ground adaptation	Individual harrow arrays with a width of 193 cm
Trailing implements:	Cambridge roller d = 530 mm Tooth roller d = 410 mm
Minimum tractor performance:	100 kW
Special features	All components can be used individually or in different combinations
Special accessories	<ul style="list-style-type: none"> - Pneumatic brakes - Operating hours counter - Warning signs lighting - Mounting set for PS 120 – 500 - Filling steps for the seed drill - Sensor set – Radar + lifting unit sensor - 40 km/h version

TD combination options GP – PS

GP/PS	Dimension (delivery) LxWxH [m]	Dimension (road transport) LxWxH [m]	Dimension (road transport) LxWxH [m]	GP weight [kg]	PS120 E	PS120 H	PS200 E	PS200 H	PS300 E	PS300 H	PS500 E	PS500 H	PS800	Parts for mounting
					Dimension HxWxD[cm]	Dimension HxWxD[cm]	Dimension HxWxD[cm]	Dimension HxWxD[cm]	Dimension HxWxD[cm]	Dimension HxWxD[cm]	Dimension HxWxD[cm]	Dimension HxWxD[cm]	Dimension HxWxD[cm]	
	Without PS	Without PS	With PS500	Without PS	88x60x79	88x60x105	100x70x88	100x70x110	110x77x100	110x77x150	117x80x122	117x80x125	127x105x170	
GP 300 roller 530 mm	2.45x3.00x1.30	2.45x3.00x1.30	2.45x3.00x2.20	~ 1640	YES	NO*	YES	NO*	YES	NO*	YES	NO	NO	
GP 300 roller 390 mm	2.45x3.00x1.30	2.45x3.00x1.30	2.45x3.00x2.20	~ 1230	YES	NO*	YES	NO*	YES	NO*	YES	NO	NO	
GP 300 tooth roller 410 mm	2.45x3.00x1.30	2.45x3.00x1.30	2.45x3.00x2.20	~ 1640	YES	NO*	YES	NO*	YES	NO*	YES	NO	NO	
GP 600 roller 530 mm	5.70x3.00x3.10	5.70x3.00x3.10	5.70x3.00x3.10	~ 4800	NO	YES	NO	YES	NO	YES	NO	YES	NO	Mounting kit PS120-500
GP 600 tooth roller 410 mm	5.70x3.00x3.10	5.70x3.00x3.10	5.70x3.00x3.10	~ 4800	NO	YES	NO	YES	NO	YES	NO	YES	NO	Mounting kit PS120-500

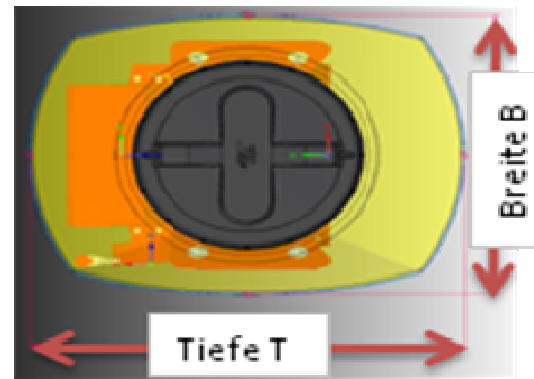
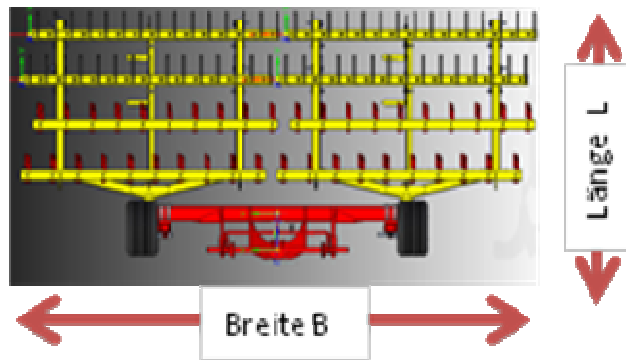

* More inexpensive version possible

14 Road transport of the GP 600 M1

- When using public roads, comply with the respective national road traffic regulations.
- Make sure that none of the safety splints or similar were lost during operation.
- Before road transport, check that the hydraulic and brake system are properly connected and also that the parking brake is released before starting to drive. Check the braking effect before departing.
- Check for proper function of the lighting as well as good visibility of the warning signs with lighting (accessories).
- Secure the GP 600 M1 side parts in transport position against dangerous changes in the load by using the intended folding lock (stop valve + chain).
- Adapt your driving speed to the current conditions.
- Only relieve the hydraulic hoses at home (by putting the tractor control unit into float position).
- Remove harrow residues to not lose them on the road (grass, soil,...).

15 Lighting circuit diagram

- 1 12 V plug, 7-pin
- 2 Rear light, right
 - 2.1 Turn signal
 - 2.2 Rear light
 - 2.3 Brake light
- 3 Rear light, left
 - 3.1 Brake light
 - 3.2 Rear light
 - 3.3 Turn signal

Plug and cable assignment:

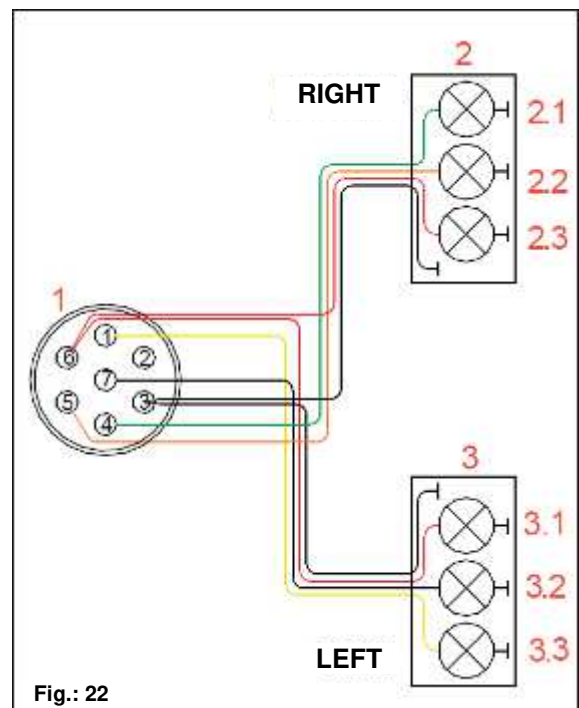

No.	Designation	Colour	Function
1	L	yellow	Turn signal, left
2	54g	----	----
3	31	white	Ground
4	R	green	Turn signal, right
5	58R	brown	Rear light, right
6	54	red	Brake light
7	58L	black	Rear light, left

16 Accessories

The following parts are available as accessories:

16.1 Compressed air system (only when ordered separately)

(Item no.: 06000-2-728)

16.1.1 General



CAUTION: Since the brakes are immediately triggered when the compressed air reservoir is full, it is important to observe the connection sequence! For this reason, before connecting the supply line (red), the GP 600 M1 must be connected to the lower links and the tractor's parking brake must be applied.

The GP 600 M1 is equipped with a dual-circuit pneumatic brake system. The supply reservoir has a volume of 20 litres. From the tractor, the two compressed air lines (supply and brake line) lead to the brake valve. From the brake valve, one line leads to the supply reservoir, the other to the wheel brake cylinders.



Fig.: 23

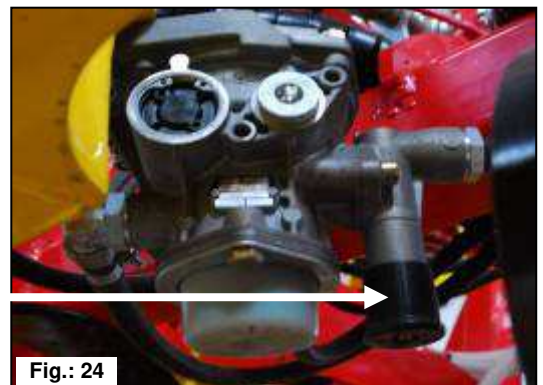

Fig.: 24



TIP: If a compressed air line on the GP 600 M1 should become defective, the GP 600 M1 can still be moved by manually triggering the pressure reservoir on the trailer brake valve (see Fig. 24 and 25). But it is then no longer permitted to drive on public roads.

16.1.2 Draining

On the bottom side of the supply reservoir, there is a drainage valve. It must be actuated weekly throughout the year and daily in the winter.



Fig.: 25



TIP: Drain the air reservoir daily. Using a wire, move the pin in a sideward direction.

If the drainage valve should become too dirty, screw it out of the pressure reservoir and clean it thoroughly. (CAUTION! The reservoir is under pressure!)

16.1.3 Readjusting the brake system

In the middle of the axle, there is a diaphragm cylinder. It can be readjusted using a threaded rod if necessary. The path from actuation of the cylinder to active braking may only account for max. one third (ca. 25 mm) of the total stroke.

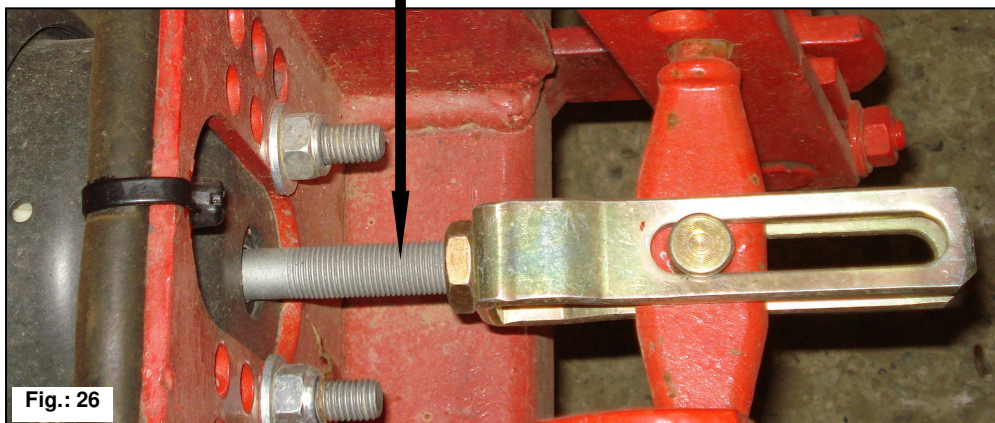

16.1.4 Measuring the compressed air

It is possible to measure the compressed air at two locations using a pressure gauge. One location is the supply reservoir and the other is beside the diaphragm cylinder.

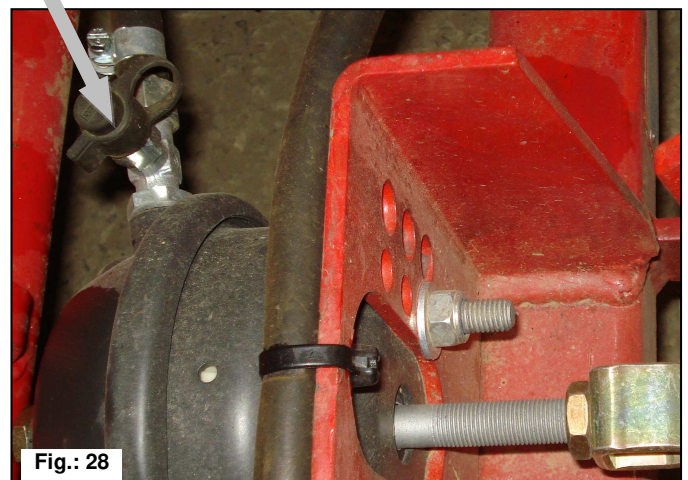

16.1.5 Pneumatic brake system diagram

The diagram of the dual-circuit pneumatic brake system is as follows:

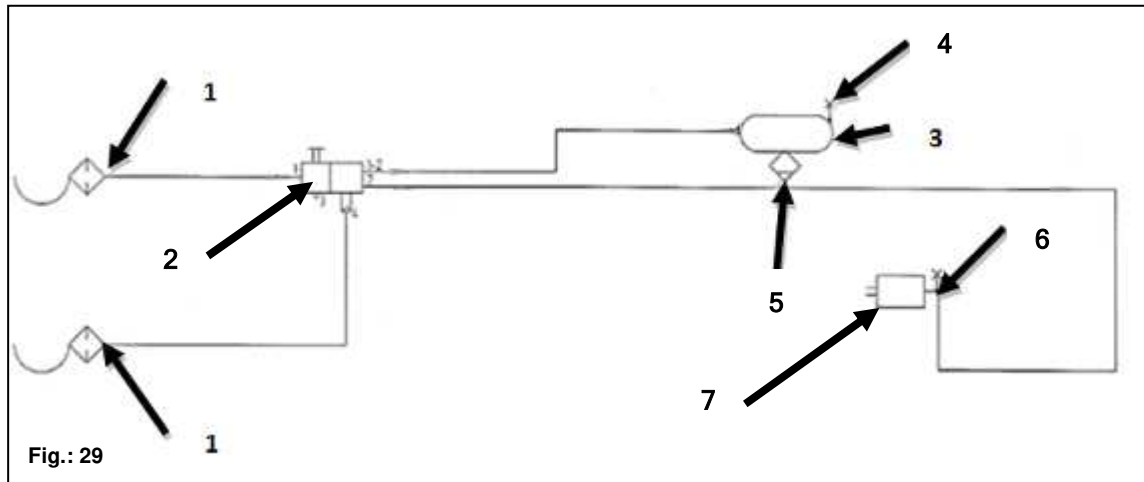

1. Connection coupling
2. Trailer brake valve
3. Supply reservoir 20 l
4. Test connection
5. Drainage valve
6. Test connection
7. Diaphragm cylinder

16.2 Operating hours counter

A vibration sensor detects the vibrations of the implement and starts the operating hours counter.

(Item no.: 00602-3-659)



16.3 Lighting with warning signs (on both sides)

Is required when the GP is transported on public roads.

(Item no.: 06001-2-021)



Fig.: 31

16.4 Mounting kit for PS120 - 500

For attaching the PS 120/200/300/500 M1 and the PS 250 M2 on the GP 600 M1.

(Item no.: 06004-2-078)



16.5 Filling steps

To facilitate refilling of the seed hopper.

(Item no.: 06004-2-036)



CAUTION: As a matter of principle, it is forbidden to carry people on the implement and/or to climb onto the running implement. Instruct people to leave the loading board before driving with the implement.

When folded down, the steps are easily and securely attached with an elastic band (Fig.: 34).

A rubber stop (Fig.: 33) prevents the ladder from being damaged when it is folded down. It also ensures that the ladder can never be positioned too steeply.



Fig.: 33



Fig.: 34

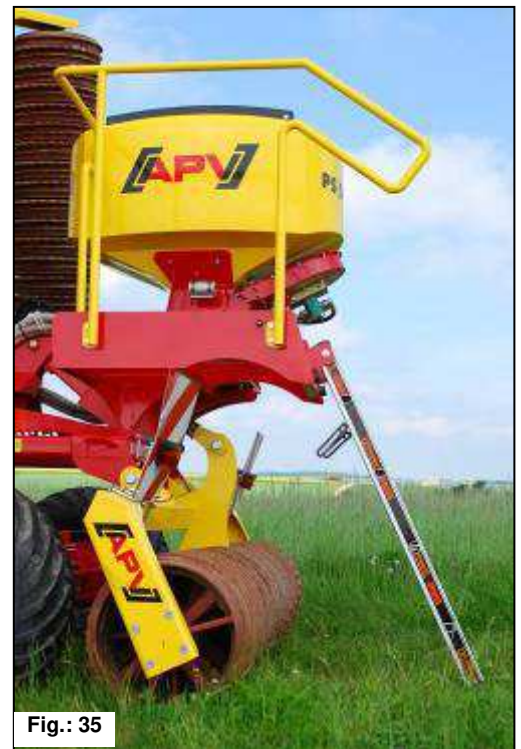

Fig.: 35

16.6 Toolbox accessories kit

(Item no.: 06004-2-115)

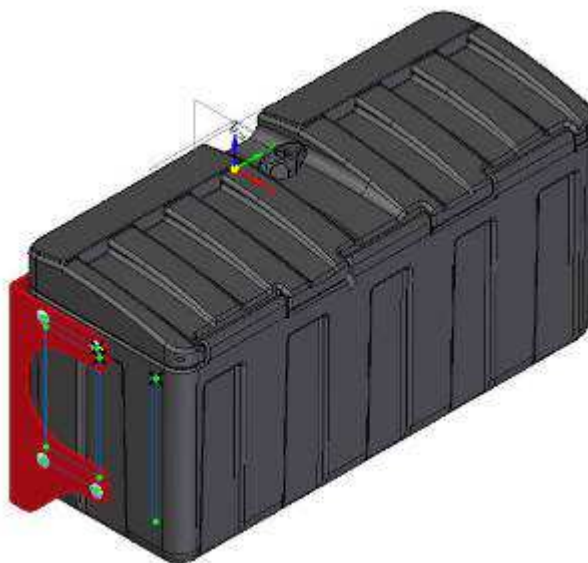

Fig.: 36

16.7 Sensor set – Radar + lifting unit sensor for the GP 600 M1

(Item no.: 06004-2-067)



Fig.: 37



Fig.: 38

The radar sensor measures the speed, which is displayed on the control box (5.2) and the seed rate is automatically regulated. This radar sensor works on almost any surface (e.g. grass, soil, sand, etc.). It is installed on the drawbar of the GP 600 M1. The lifting unit sensor interrupts the metering at the headland.



TIP: Before driving off for the first time, calibrate the speed on the control box 5.2.

This kit includes:

- ✓ **Lifting unit sensor for the running gear**
- ✓ **Lifting unit sensor for the roller cylinder**



CAUTION: To activate the meter roll of the pneumatic seed drill (PS) in working position, both sensors must be positioned over the magnets.

- ✓ **2 lifting unit sensors (running gear and roller) and one radar sensor**



With these sensors, the PS (if mounted) is controlled.

- **40 km/h version with TÜV (only when ordered separately)**

With this version, it is permitted to drive on public roads at 40 km/h.

(Item no.: 06004-2-088)

- ✓ **Wheel chocks accessories kit**
With this kit, the implement can be secured against rolling away.
(Item no.:06004-2-087)



Fig.: 42

- ✓ **Tine protection with holder**
With this protection, the bottom tine rows of the outer tine arrays are covered. During operation, the cover can be conveniently stowed.



Fig.: 43



Fig.: 44

✓

✓ Lighting with side limiting and reflectors



- **Parking brake**

With this parking brake, the implement can be secured against rolling away.

(Item no.: 06004-2-086)



- **Bigger tyres** (item no.: 06004-2-107) (see Fig.: 52) and a **bigger braking axle, which allows 40 km/h.**

- **Warning sign lighting GP 600 M1** (item no. 06004-2-094) (see Fig.: 53)

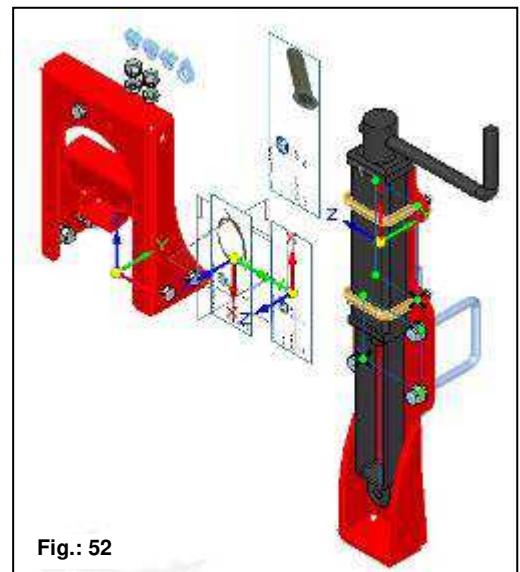
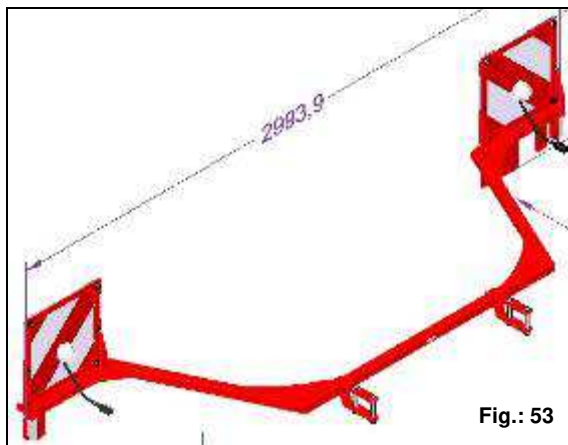

17 My idea

The GP 600 M1 was extensively developed and tested. It took a long time from the initial idea to serial production. It required lots of commitment from individual employees and the entire development team.

We collaborated with universities, specialists from the field and initiated research projects.

Nonetheless, the most valuable experience is gained in practice. Our motto:

"Inspired by Farmers & realized by Professionals."

For this reason, YOU are also the most important person for the development of agricultural machinery for practical use.

Without taking consideration of your opinions, experiences, enthusiasm, desires, and also your troubles, further development and constant improvement of our implements would not be possible.

We are now giving you the opportunity to effectively contribute to the development and improvement of our machines.

Tell us about the positive and negative experiences you have had with the machine. Share your suggestions for improvement and your wishes!

Take pictures or draw a sketch, we are open and grateful for any information, no matter in what form.

Send this information to meineidee@apv.at, fax it to +43/2913/8002 or send us a letter to our address. Key word: My idea.

The information will be forwarded directly to our construction department and will be discussed and considered. Please do not forget to tell us the serial number of your machine.

Please understand that we cannot take suggestions for improvement by phone, since it requires too much organisation. However, if you still wish for personal contact, you can share your experiences with our sales representatives at fairs and field days. Of course, we are there for you at all times if you have an urgent problem. Please just call us or direct your inquiry to the nearest distribution partner.

Good ideas are important to us – and will therefore also be rewarded. If one of your ideas is implemented, you will receive a practical gift as a token of our appreciation.

I thank you in advance for your constructive suggestions and remain

Sincerely yours



Ing. Gregor Witzmann
Development / Engineering

18 Safety instructions



For your safety...

This supplement to the operating manual contains general rules of conduct for the intended use of the implement and safety-related information that should always be observed for your personal safety.

The list is very extensive, and some of the information does not apply exclusively to the delivered implement. However, the summary of the information often reminds you of unconsciously neglected safety regulations for the everyday operation of machines and implements.

18.1 Intended use

The implement is designed solely for normal use in agricultural operations (intended use).

Any other use is considered to be non-intended. The manufacturer is not liable for any resulting damage, the operator alone bears the associated risk.

Intended use also includes compliance with the conditions for operation, maintenance, and repairs prescribed by the manufacturer.

The implement may only be used, maintained and repaired by persons who have relevant experience and were instructed on the risks. The safety instructions must also be handed over to other users.

The applicable accident prevention regulations as well as the other generally safety-related, occupational health and road traffic regulations must also be observed.

The manufacturer is not liable for any damage resulting from unauthorised modifications and the use of components and auxiliary parts.

18.2 General safety-related instructions and accident prevention regulations

- Check the implement and the tractor for road and operational safety before every use!
- Observe the generally applicable safety and accident prevention regulations!
- The warning and information signs applied to the implement provide important instructions for safe operation, observe them for the sake of your own safety!
- Observe the respective regulations when using public roads!
- Before starting work, get to know all of the equipment and operating elements as well as their functions. It is too late to do so during operation!
- The user should wear close-fitting clothing. Avoid wearing loose clothes!
- Keep the implements clean to reduce the risk of fire!
- Check the surrounding area before starting up and operating the implement! (Children!) Ensure sufficient visibility!
- It is not allowed to carry passengers on the implement during operation and transport!
- The implement must be coupled according to the instructions and only onto the specified devices!
- Special care must be taken when coupling and uncoupling implement to and from the tractor!
- When mounting and dismounting, put the support devices in their respective positions! (Stability!)
- Always attach ballast weights at the intended attachment points according to the specifications!
- Observe the permissible axle load, total weight and transport dimensions!
- Transport equipment - e.g. lighting, warning signs and any protective equipment, must be checked and mounted!
- Triggers for quick couplings must be hanging loosely and must not trigger themselves when lowered.
- Never leave the driver's platform while driving!
- The driving behaviour, steering and braking capacity are also affected by mounted or towed implements and ballast weights. For this reason, always ensure sufficient steering and braking capacity!
- When driving in curves, take account of the wide radius and/or the centrifugal mass of the implement!
- The implement may only be operated when all of the protective devices are installed and in safety position!
- It is forbidden to stand in the working area of the implement!
- Do not stand near rotating and swivelling parts of the implement!
- Hydraulic folding frames may only be actuated when nobody is standing in the swivelling range.
- There are pinch and shear points on externally powered (e.g. hydraulic) parts!
- On implements with manual folding, always ensure that the implement is stable!
- For implements that are driven at high speeds with soil-driven tools - Danger after lifting due to the still rotating centrifugal mass! Only approach the implement when it has come to a standstill!

- Before exiting the tractor, lower the implement onto the ground, switch off the motor and remove the ignition key!
- Standing between the tractor and the implement is forbidden unless the vehicle is secured against rolling away using the parking brake and/or with wheel chocks!
- Folded frames and lifting devices must be locked in transport position!
- Packer catch arms must be swivelled in and locked before road transport!
- Lock the track markers in transport position!
- The view on the grassland power harrow and the hazardous movement area must be clear to check the procedure.
- The implements must be checked regularly by the operator (before every use) for any fractures and cracks, chafe marks, leaks, loose bolts and connections, vibrations, unusual sounds, and to ensure they function correctly. The implements should be cleaned regularly using water or compressed air. Maintenance and cleaning work must be carried out with the implement lowered, shut down and secured to prevent it being switched on again. Working under the implement is forbidden.
- Hearing protection should be used, if necessary.
- During assembly, the operator must ensure that the requirements for the tractor in terms of the power, axle loads and weight distribution as specified in the operating manual are met and that the connections specified in the operating instructions are made correctly.
- When mounting the implement, the operator must ensure that connections to the tractor hydraulic system are clean and carefully connected.
- When mounting the grassland power harrow, the operator must ensure that there is a metallic connection made to the tractor.
- The operator must ensure that no one is standing close to the grassland power harrow when it or its components are being moved by the tractor hydraulic system or when the roller is being lifted or lowered. Visual check by the driver!
- When performing the work passes, the tractor's speed must be maintained as specified in the operating instructions. This can be between 6 and 12 km/h.
- The specifications in the operating manual regarding mounting as well as the calculation of the weight ratios and the axle loads of the tractor must be observed.
- When driving on roads, which is only permitted with the running gear extended (both wheels) and with folded side wings and Cambridge rollers, the control block on the running gear cylinder prevents lowering of the grassland power harrow as well as of the folded up components (additionally secured with a chain), also in case of failure of the tractor hydraulic system.

18.3 Mounted implements

- Before mounting and dismounting implements on the three-point linkage, move the operating devices into the position that excludes unintentional lifting or lowering!
- For three-point mounting, the mounting categories of the tractor and the implement must match or be adapted!
- There is a risk of injury due to crushing and shearing points in the area of the three-point linkage!
- Do not stand between the tractor and the implement when actuating the external controls for the three-point mounting!
- When the implement is in transport position, always ensure that the tractor three-point linkage is sufficiently locked to the sides!
- When driving on roads with the implement lifted, the operating lever must be locked against lowering!

18.4 Hydraulic system

- The hydraulic system is under high pressure!
- When connecting hydraulic cylinders and motors, the specified connection of the hydraulic hoses must be observed!
- When connecting the hydraulic hoses to the tractor hydraulic system, make sure that the hydraulic system on the tractor and implement side is unpressurised!
- For hydraulic function connections between the tractor and the implement, coupling sleeves and connectors should be marked to rule out operating errors! If the connections are interchanged, the function will be inverted! (e.g., lifting/lowering) – Risk of accident!
- Inspect the hydraulic hose lines at regular intervals and replace in case of damage or wear! The replacement lines must comply with the technical requirements of the implement manufacturer!
- Due to the risk of injury, use suitable tools when searching for leaks!
- Liquids escaping under high pressure (hydraulic oil) can penetrate skin and cause serious injuries! Consult a doctor immediately in case of injury! (Risk of infection!)
- Before working on the hydraulic system, park the implement, depressurize the system and switch off the motor!
- The safety chain should only be unhooked when it is relieved of tension! (Cylinder must be filled with oil.)

18.5 Maintenance













- Maintenance, repair, and cleaning work as well as the elimination of malfunctions should always be performed when the drive is switched off and the motor is at a standstill! – Remove the ignition key!
- Check the nuts and bolts regularly for tight fit and retighten if necessary!
- When performing maintenance on the lifted implement, always ensure safety through suitable support elements!
- When changing work tools with sharp edges, always use suitable tools and gloves!
- Properly dispose of oils, grease and filters!
- Always cut the power supply when working on the electrical system!
- When performing electrical welding work on the tractor and mounted implement, disconnect the cable on the generator and the battery!
- Spare parts must at least comply with the technical requirements specified by the implement manufacturer! This is ensured with original parts!
- Use additional lighting (e.g. flashlight) if necessary for repair or maintenance work!



PLEASE NOTE: Misprints, errors and omissions excepted!

19 Safety signs

Pay special attention to these stickers on the implement, as they warn you of specific dangers!

<p>Read and observe the operating manual before operating the implement!</p>	 	<p>Do not stand on the implement while driving!</p>	 
<p>Before maintenance work, be sure to switch off the motor and pull out the key!</p>	 	<p>Never reach into the crushing danger zone as long as the parts can still move!</p>	 
<p>Do not stand between the machines when connecting the GP 600 M1 and actuating the hydraulic system!</p>	 	<p>Be careful with escaping high-pressure liquids. Observe the instructions in the operating manual!</p>	 

Do not stand in the swivelling area of folding implement parts!



Standing in the danger zone is only permitted when the lifting cylinder lock is inserted.



Do not climb onto rotating parts, use the intended access ladders!



Danger due to thrown parts; observe the safety distance!



Standing in the danger zone is only permitted when the safety support is inserted.



Never reach into the crushing danger zone as long as the parts can still move!



To avoid eye injuries, do not look directly into the beam area of the radar sensor when it is switched on!



Always plug all of the hydraulic lines. Otherwise components can be damaged because of connected hydraulic functions.

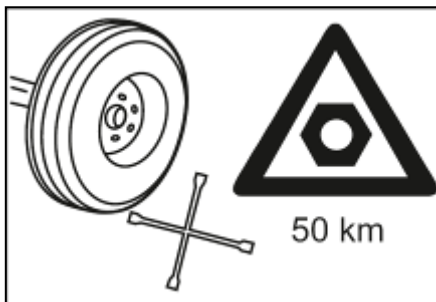
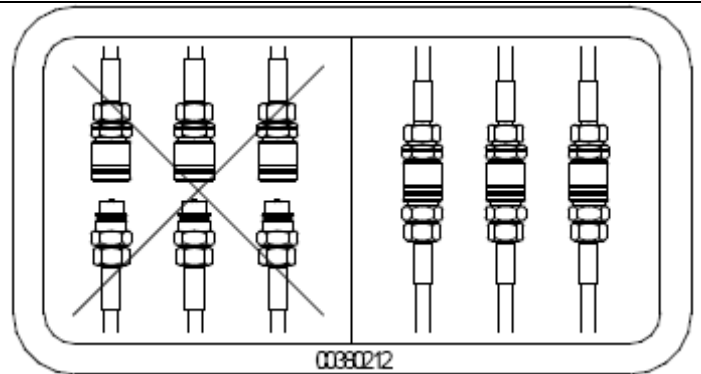

Retighten the wheel nuts / wheel bolts after 50 hours or 50 km.

Loading hooks; when loading the machine, attach the ropes or chains to these points!

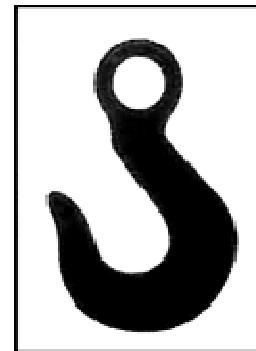

This sticker identifies grease points. These should be lubricated with universal grease approx. every 10 operating hours.

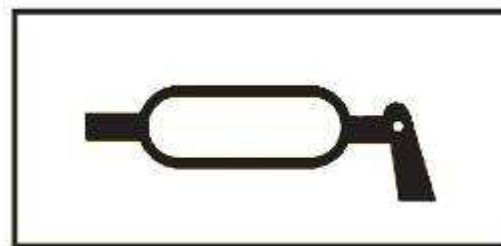

These stickers indicate the tyre inflation pressure.

2,2 bar
32 psi

3,4 bar
50 psi

Quality for Professionals

Inspired by Farmers & realized by Professionals



**APV - Technische Produkte GmbH
HEADQUARTER
Dallein 15
A-3753 Hötzelstdorf**

**Tel.: +43 (0)2913 8001
Fax: +43 (0)2913 8002**

**www.apv.at
office@apv.at**